

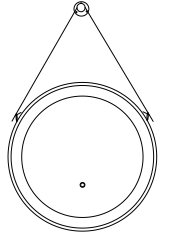



**Stück Liste**

NO.	A (1 Stk)	B(3 Stk)	C(1 Stk)	D(1 Stk)	
Foto					
Beschreibung	Spiegel	Schraube	Schnur	Aufhänger	

(1) Geben Sie die Schrauben in das Loch; (2) Befestigen Sie die Halterung;

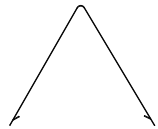

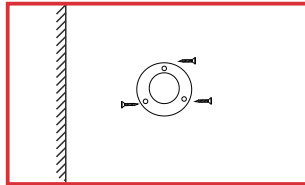
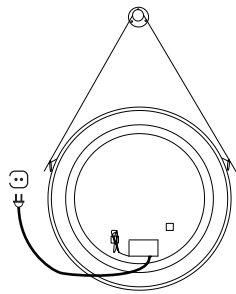
(1)

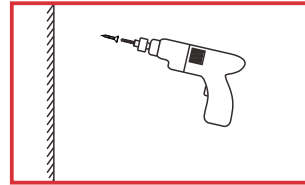

(2)

(3) Hängen Sie den LED-Spiegel mit der Schnur an die Wand.

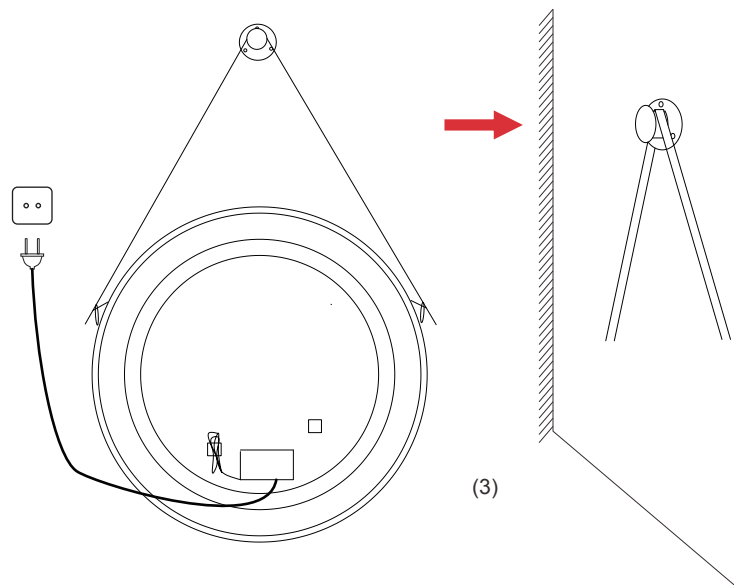

(3)

**Bedienungsanleitung**

Liebe/r Kunde/in,  
Wir danken Ihnen für Ihr Vertrauen in unsere Produkte!  
Lesen Sie die Gebrauchsanweisung sorgfältig durch, bevor Sie das Produkt zum ersten Mal verwenden! Diese Anweisungen enthalten alle Informationen, die zur sicheren Verwendung dieses Produkts und zur Verlängerung der Lebensdauer erforderlich sind. Bitte beachten Sie unbedingt alle Sicherheitshinweise in dieser Anleitung!

**Sicherheitshinweise**

Die Leuchte darf nur in Innenräumen installiert werden.  
Um dieses Produkt sicher zu betreiben, muss der Benutzer diese Gebrauchsanweisung gelesen haben, bevor Sie das Produkt zum ersten Mal verwenden.  
Das Produkt darf nur verwendet werden, wenn es unbeschädigt ist und ordnungsgemäß funktioniert. Wenn das Produkt oder Teile davon defekt sind, lassen Sie es von einem Spezialisten reparieren. Achten Sie beim Bohren in Wänden, Decken oder Fußböden auf eventuell installierte Kabel sowie Gas- und Wasserleitungen.  
Verwenden Sie nur vom Hersteller zugelassene Clips.  
Bei Betrieb im Bad müssen die Sicherheitsabstände (Abb. 3) Unbedingt eingehalten werden.  
Achten Sie darauf, dass sich in der Badewanne od. Dusche befindliche Personen, das Gerät nicht erreichen können.

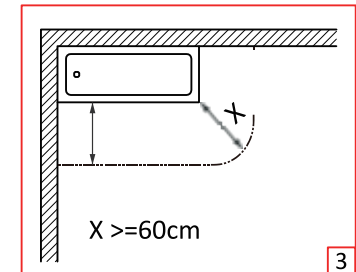

3



Der Spiegel enthält eingebaute LED-Lampen.  
Die Lampen können nicht ausgetauscht werden.

**Reinigung**

- Reinigen Sie das Produkt mit einem leicht angefeuchteten Tuch mit klarem Wasser (gegebenenfalls mit einem milden Reinigungsmittel). Trocken wischen.
- Verwenden Sie keine scharfen oder scheuernden Gegenstände oder aggressive Reinigungsmittel

**Entsorgung**

- Produkt entsorgen: Produkte, die mit dem nebenstehenden Symbol gekennzeichnet sind, dürfen nicht im Hausmüll entsorgt werden. Sie müssen solche alten elektrischen und elektronischen Geräte separat entsorgen.
- Verpackung entsorgen: Die Verpackung besteht aus Karton und entsprechend gekennzeichneten Kunststoffen, die recycelt werden können. - Stellen Sie diese Materialien für das Recycling zur Verfügung.

**Parts List**

NO.	A(1 PC)	B(3 PC)	C(1 PC)	D(1 PC)	
Photo					
Description	Mirror	Screw	Belt	Hanger	

(1) Put three screws into the hole; (2) Fix the hanger;

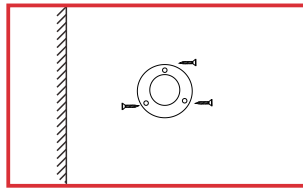
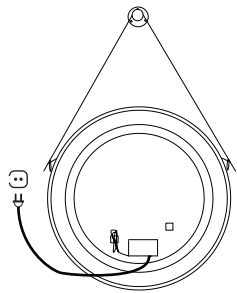

(1)

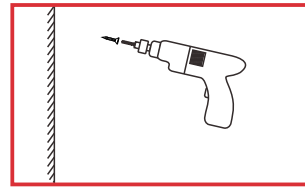

(2)

(3) Hang the LED mirror on the wall with the belt.

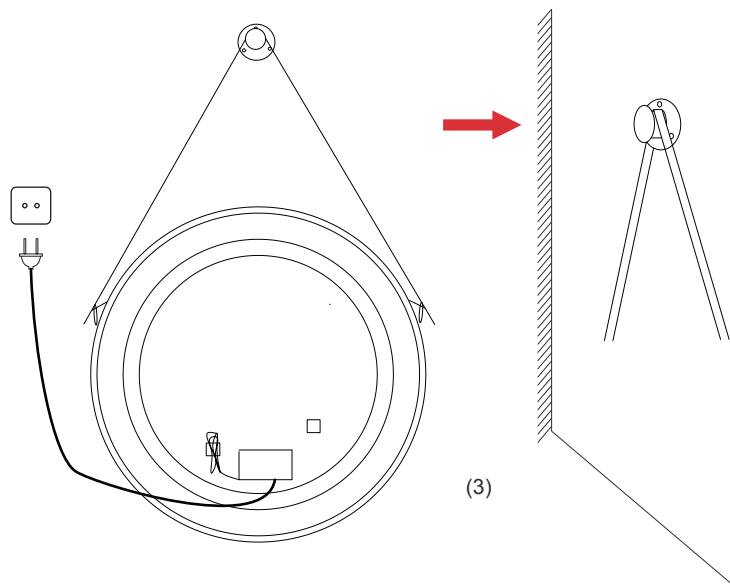

(3)

**Operating instructions**

Dear Customer,  
 We thank you for the trust you put in our products!  
 Read these instructions for use carefully before using the product for the first time!  
 These instructions contain all information necessary to safely use this product and provide for its extended lifespan. Please make sure to observe all safety information included in these instructions!

**Safety instructions**

The light may be installed indoors only.  
 To operate this product safely, the user must have read and understood these instructions for use before using the product for the first time.  
 The product may not be used unless it is undamaged and functions properly. If the product or parts of it have become defective, have it repaired by a specialised technician.  
 When drilling in walls, ceiling or floors, pay attention to any installed cables as well as gas and water lines.  
 Use only connection clips authorised by the manufacturer.  
 -For operation of the device in the bathroom, the safety distances must absolutely be adhered to ( fig. 3). it must be ensured the people who are in the bathtub or shower cannot reach the device.

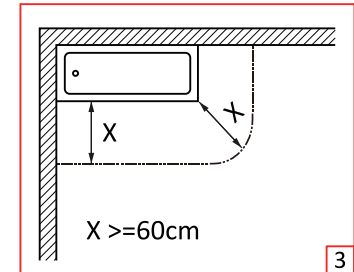

This mirror contains a built-in LED lamps.  
 The LED lamps cannot be changed.





**Cleaning**

- Clean the product with a cloth dampened slightly with clean water (with the addition of a mild cleaning agent if necessary). Wipe dry.
- Do not use any sharp or abrasive objects, or aggressive cleaning agents.

**Disposal**

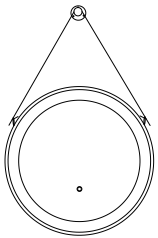
Disposing of the product  
 Products which are labelled with the adjacent symbol must not be disposed of in household rubbish. You must dispose of such old electrical and electronic equipment separately.  
 Disposing of the packaging  
 The packaging consists of cardboard and correspondingly marked plastics that can be recycled.  
 — Make these materials available for recycling.

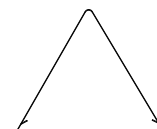
## Lista componente

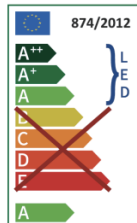
NO.	A(1 BUC)	B(3 BUC)	C(1 BUC)	D(1 BUC)	
Foto					
Descriere	Oglinda	Surub	Curea	Suport	

(1) Potriviti suruburile pe gaurile suportului; (2) Fixati suportul;

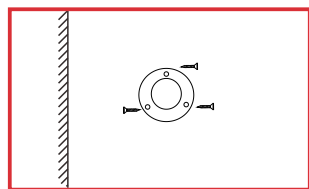
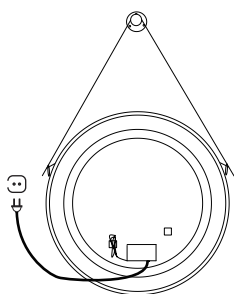

(1)

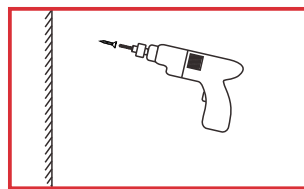

(2)

(3) Agatati oglinda pe perete cu ajutorul curelei atasate.

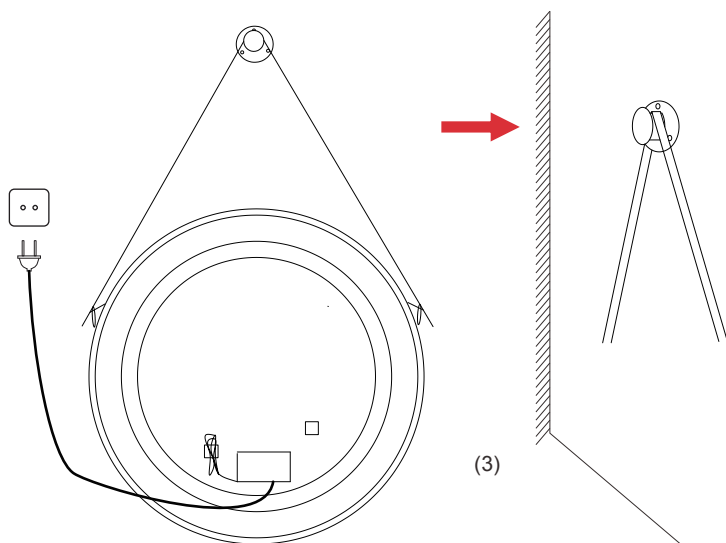

(3)

## Instrucțiuni de operare

Stimate client,

Vă mulțumim pentru încrederea pe care ați pus-o în produsele noastre!

Citiți cu atenție aceste instrucțiuni de utilizare înainte de a utiliza produsul pentru prima dată! Aceste instrucțiuni conțin toate informațiile necesare pentru utilizarea în siguranță a acestui produs și asigurarea duratei sale de viață prelungite. Asigurați-vă că respectați toate informațiile de siguranță incluse în aceste instrucțiuni!

**Instrucțiuni de siguranță**

Iluminarea poate fi instalată numai la interior.

Pentru a utiliza acest produs în siguranță, utilizatorul trebuie să fi citit și să înțeleasă aceste instrucțiuni de utilizare înainte de a utiliza produsul pentru prima dată.

Produsul nu poate fi utilizat decât dacă este nedeteriorat și funcționează corect. Dacă produsul sau componentele acestuia au devenit defecte, reparați-l doar la un tehnician specializat. Atunci când găuriți pereții, acordați atenție amplasamentului cablurilor electrice, precum și liniilor de gaz și apă. Utilizați numai clipsuri de conectare autorizate de producător.

- Pentru funcționarea dispozitivului în baie, distanțele de siguranță trebuie respectate în mod absolut (figura 3). Trebuie să vă asigurați că persoanele care sunt în cadă sau duș nu pot ajunge la dispozitiv.

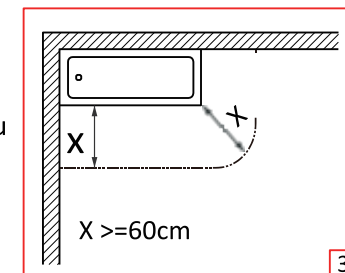

Această oglindă conține lămpi cu LED încorporate  
Lămpile cu LED nu pot fi înlocuite.

**Curățarea**

- Curățați produsul cu o cârpă umezită ușor cu apă curată (cu adăugarea unui agent de curățare ușoară, dacă este necesar). Ștergeți uscat.

- Nu folosiți obiecte ascuțite sau abrazive sau agenți de curățare agresivi.

**Eliminarea produsului**





Produsele care sunt etichetate cu simbolul adiacent nu trebuie aruncate în gunoiul menajer. Trebuie să eliminați separat aceste echipamente electrice și electronice vechi.

Eliminarea ambalajului

Ambalajul constă din carton și materiale plastice care pot fi reciclate corespunzător.

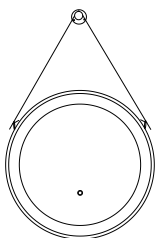
- Faceți aceste materiale disponibile pentru reciclare.

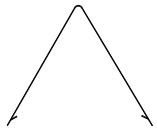
**A csomag tartalma**

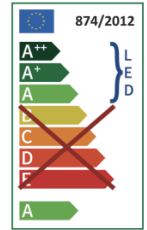
Betűjel	A (1 db)	B (3 db)	C (1 db)	D (1 db)	
Kép					
Leírás	Tükör	Csavar	Pánt	Akasztó	

- (1) Jelölje be a falon az akasztón található lyukak helyét, majd fúrja ki azokat;  
 (2) Csavarozza fel az akasztót;

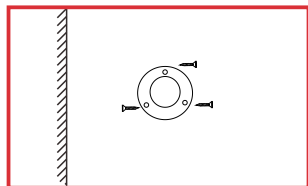
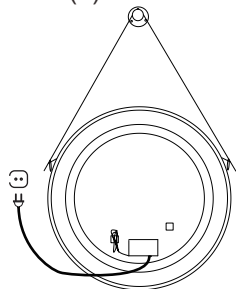

(1)

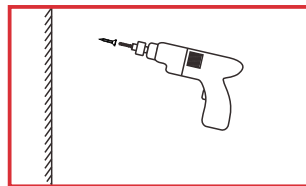

(2)

- (3) Akassza a falra a tükröt a pánt segítségével.

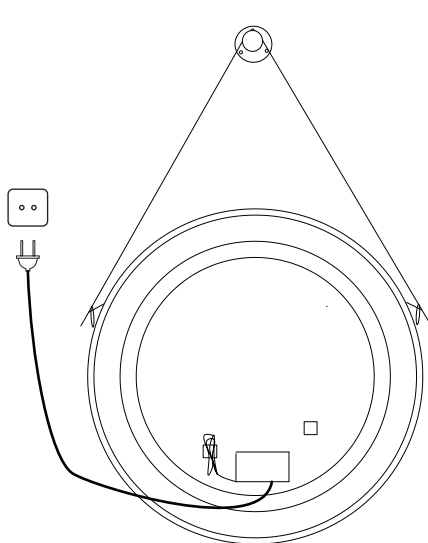

(3)

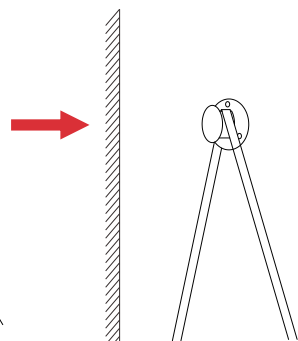
**Használati útmutató**

Tisztelt Vásárlónk!

Köszönjük, hogy a SANOTECHNIK termékét választotta.

A tükrő felszerelése előtt figyelmesen olvassa el a használati útmutatót!

Az útmutató tartalmaz minden információt a termék hosszú távú biztonságos használatához. Kérjük, hogy a használatba vétel előtt győződjön meg róla, hogy minden intézkedést betartott.

**Biztonsági intézkedések**

A tükrő kizárólag beltéri használatra alkalmas!

Kérjük, hogy a tükröt csak akkor szerelje fel és kezdje használni, ha a termék sérülésmentes. Ha sérülést tapasztal, értesítse viszonteladóját.

Ha a termék elektromos részei a használat során megsérülnek vagy meghibásodnak, kérje szakember segítségét a javítási munkák elvégzéséhez.

A felszerelésnél ügyeljen rá, hogy a kívánt helyen a falban nem fut sem elektromos, sem víz- vagy gázvezeték, nehogy megfúrja azokat.

A rögzítéshez ne használja más gyártó alkatrészeit!

A tükrő fürdőszobai használatához az ábrán jelzett biztonsági távolságot maradéktalanul tartsa be!

A tükröt a fürdőkádtól és/vagy zuhanyzótól kartávolságon kívül szerelje fel!

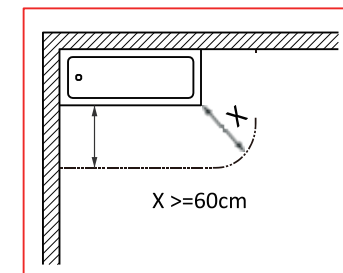

A tükrő beépített LED-fényforrást tartalmaz.

A fényforrás a végfelhasználó által rendeltetésszerűen nem cserélhető.

**Tisztítás**





- A tükröt enyhén nedves kendővel tisztítsa meg, majd törölje szárazra. Ha szükséges, a tiszta víz helyett használjon kímélő tisztítószeret.
- Soha ne használjon agresszív tisztítószeret vagy éles, érdes tárgyat a tisztításhoz!

**Hulladékkezelés**

- A termék – a csomagoláson szereplő szimbólumnak megfelelően - nem kezelhető háztartási hulladékként. Minden más elektromos készülékhez hasonlóan a háztartási hulladéktól elkülönítve kezelendő!
- A csomagolás kartonpapírból és megfelelő jelöléssel ellátott műanyagból készült, ami újrahasznosítható. Ezen anyagokat gyűjtse szelektíven!

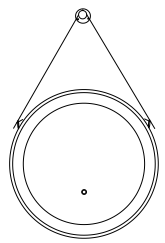

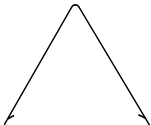
## Vsebina

ŠT.	A (1 KOS)	B (3 KOS)	C (1 KOS)	D (1 KOS)	
Slika					
Opis	Ogledalo	vijak	Trak	Obešalnik	

(1) Vijak privijte v zidni vložek;

(2) Nosilec pritrdite na steno;

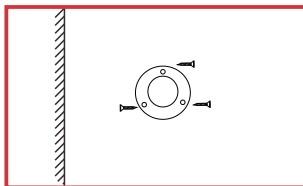
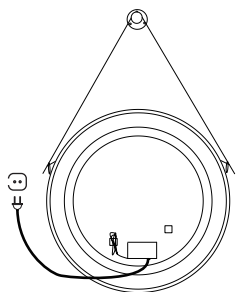

(1)

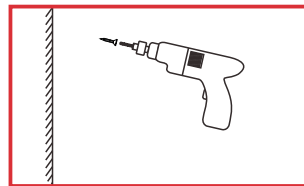

(2)

(3) Obesite led ogledalo s trakom na nosilec.

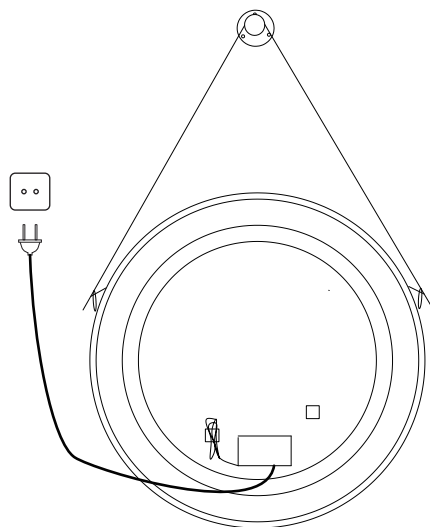

(3)

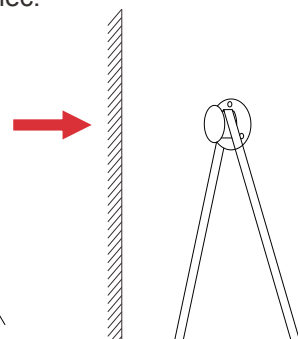

## Navodila za montažo in uporabo

Dragi kupec,

Hvala za zaupanje, ki ste nam ga izkazali z nakupom našega izdelka!

Pred prvo uporabo natančno preberite navodila o uporabi! Ta navodila vsebujejo vse potrebne podatke za varno in normalno uporabo izdelka do svoje pričakovane življenske dobe. Ob tem je potrebo upoštevati vsa varnostna opozorila, ki so v the navodilih!

**Varnostna opozorila**

Ogledalo je namenjeno montaži samo v notranjih prostorih.

Da lahko izdelek uporabljate varno, morate pred prvo uporabo prebrati in razumeti ta navodila.

Izdelek se ne sme uporabljati, če je poškodovan ali ne deluje pravilno. Če se izdelek ali deli izdelka pokvarijo, jih dajte popraviti za to pooblaščenim serviserjem. Ob vrtnanju v zidove, stropove ali tla, pazite na električne, plinske in vodne inštalacije.

Uporabite le električne sponke, ki jih priporoča proizvajalec.

Ob namestitvi ogledala v kopalnicah, upoštevajte varnostno razdaljo namestitve (slika 3). Razdalja od tuš kabine ali kopalne kadi mora biti takšna, da oseba od tam ne more doseči ogledala.

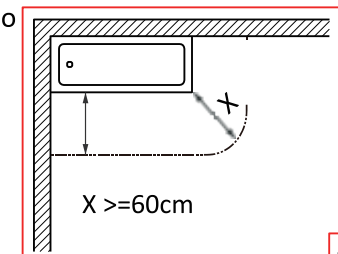

3



Ogledalo vsebuje vgrajeno LED svetilko.  
LED svetilke ni mogoče zamenjati.

**Čiščenje**

Izdelek čistite z rahlo vlažno krpo, namočeno v vodo z dodanim blagim čistilom. Obrišite do suhega.

Ne uporabljajte ostrih ali nevarnih predmetov ali agresivnih čistilnih sredstev.





**Odstranjevanje**

Izdelki ali deli izdelkov, ki so posebej označeni posebno nalepko, se po uporabi ne smejo odvreči v gospodinjne odpadke. Električne in elektronske dele morate odvreči v zato namenjene prostore.

**Embalaža**

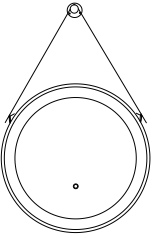
Embalaža je iz kartona in posebne plastike, ki ju lahko recikliramo. Zato se takšna embalaža oddaja v predelovalnice embalaže.

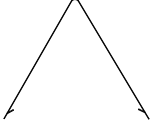
## Parts List

NO.	A(1 PCS)	B(3 PCS)	C(1 PCS)	D(1 PCS)	
					
	Огледало	Винт	Ремък	Закачалка	

(1) Поставете винта в отвора;

(2) Фиксирайте закачалката;

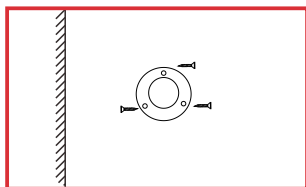
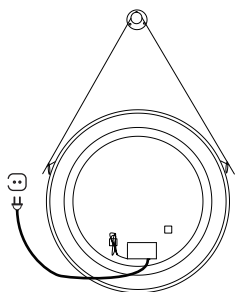

(1)

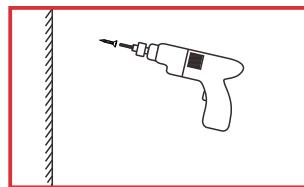

(2)

(3) Окачете ЛЕД огледалото на стената с ремъка.

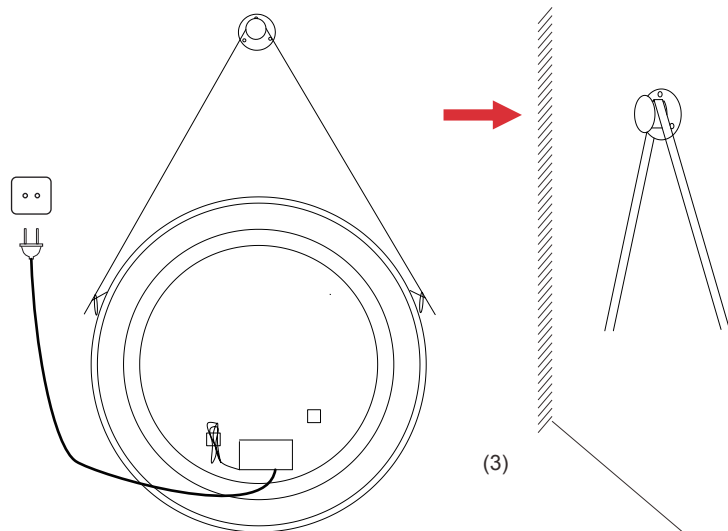

(3)

## Инструкция за монтаж

Уважаеми клиенти, благодарим Ви за доверието към нашите продукти! Прочетете внимателно инструкцията за употреба преди да използвате продукта за първи път! Тази инструкция съдържа цялата информация, необходима за безопасното използване на този продукт и осигуряване на удължен живот. Моля, спазвайте всички указания за безопасност, включени в тези инструкции!

**Инструкции за безопасност**

Продукта може да се инсталира само на закрито.

За да използвате този продукт безопасно, потребителят трябва да е прочел и разбрал тези инструкции за употреба, преди да използва продукта за първи път. Ако продуктът или части от него са дефектни, поправката следва да се извърши от специализиран техник. Когато пробивате стени, тавани или подове, обърнете внимание на всички инсталирани кабели, както и на газови и водни линии. Използвайте само свързващи скоби, разрешени от производителя.

- За работа на устройството в банята трябва да се спазват безопасно разстоянията (фигура 3).

- трябва да се гарантира, че хората, които са във ваната или душ не могат да стигнат до устройството.

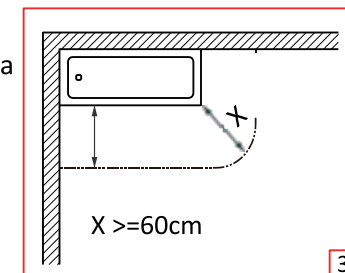

3



Огледалото е с вградено ЛЕД осветление. ЛЕД крушката не може да се подменя.

**Почистване**

- Почистете продукта с леко навлажнена кърпа с чиста вода (с добавяне на мек почистващ препарат, ако е необходимо). Избършете.
- Do not use any sharp or abrasive objects, or aggressive cleaning agents.

**Рециклиране на продукта**

Трябва да изхвърляте такова старо електрическо и електронно оборудване отделно.

**Изхвърляне на опаковката**

Опаковката се състои от картон и съответно маркирани пластмаси, които могат да бъдат рециклирани.