

- D Montageanleitung  
 E Mounting Instruction  
 HR Uputi za upotrebu  
 SLO Navodlilo za monta o kadi  
 HU Útmutató a zuhanykabin beszereléséhez  
 RO Instructiuni de montaj  
 CZ Návod k montá l vany  
 SK Návod na montáž  
 TR Montaj Klavuzu  
 BG Инструкции за монтаж

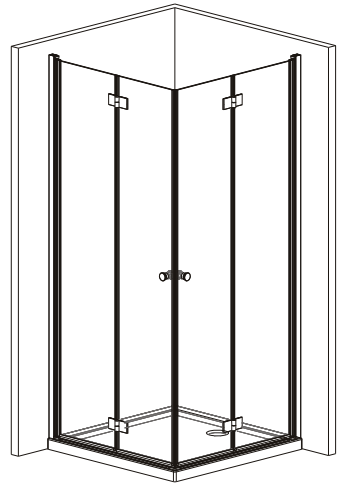

# OPTIMA

## BLACK

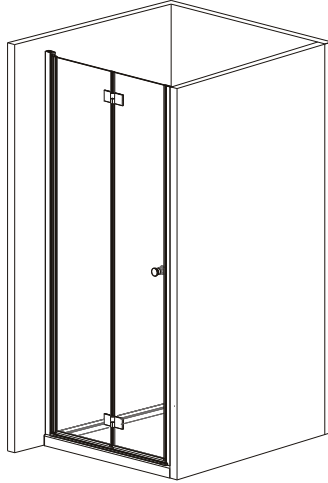

Symbol foto  
202208



**SANOTECHNIK**  
 Handelsgesellschaft m.b.H.  
 Industriestraße 5  
 A-2752 Wöllersdorf  
 Tel.: +43 2622 / 421 93 0  
 Fax: +43 2622 / 421 93 6  
 office@sanotechnik.at  
 www.sanotechnik.com



**SANOTECHNIK** Hungária Kft.  
 MAGYARORSZÁG  
 Nagytétényi út 112  
 H-1222 BUDAPEST  
 Tel.: (+36 1) 424 06 70  
 Fax: (+36 1) 424 06 79  
 info@sanotechnik.hu  
 www.sanotechnik.com



**SC Sanotechnik COM** Rumänien S.R.L.  
 ROMANIA  
 Tancabesti, DN 1, KM 26,5  
 Com. Snagov, jud. Ilfov  
 Tel.: +40 21 350 13 43  
 Fax: +40 21 350 13 44  
 office@sanotechnik.ro  
 www.sanotechnik.com



**SANOTECHNIK** d.o.o.  
 SLOVENIJA  
 Stritarjeva ulica 24  
 SI-2000 MARIBOR  
 Tel. +3862/4213350  
 Fax +3862/4213358  
 info@sanotechnik.si  
 www.sanotechnik.com



**Sanotechnik Bulgaria Ltd.**  
 BULGARIA  
 3, Georgi Benev St.  
 BG-4003 Plovdiv  
 Tel: +359 32 961101  
 Fax: +359 32 961102  
 office@sanotechnik.bg  
 www.sanotechnik.com







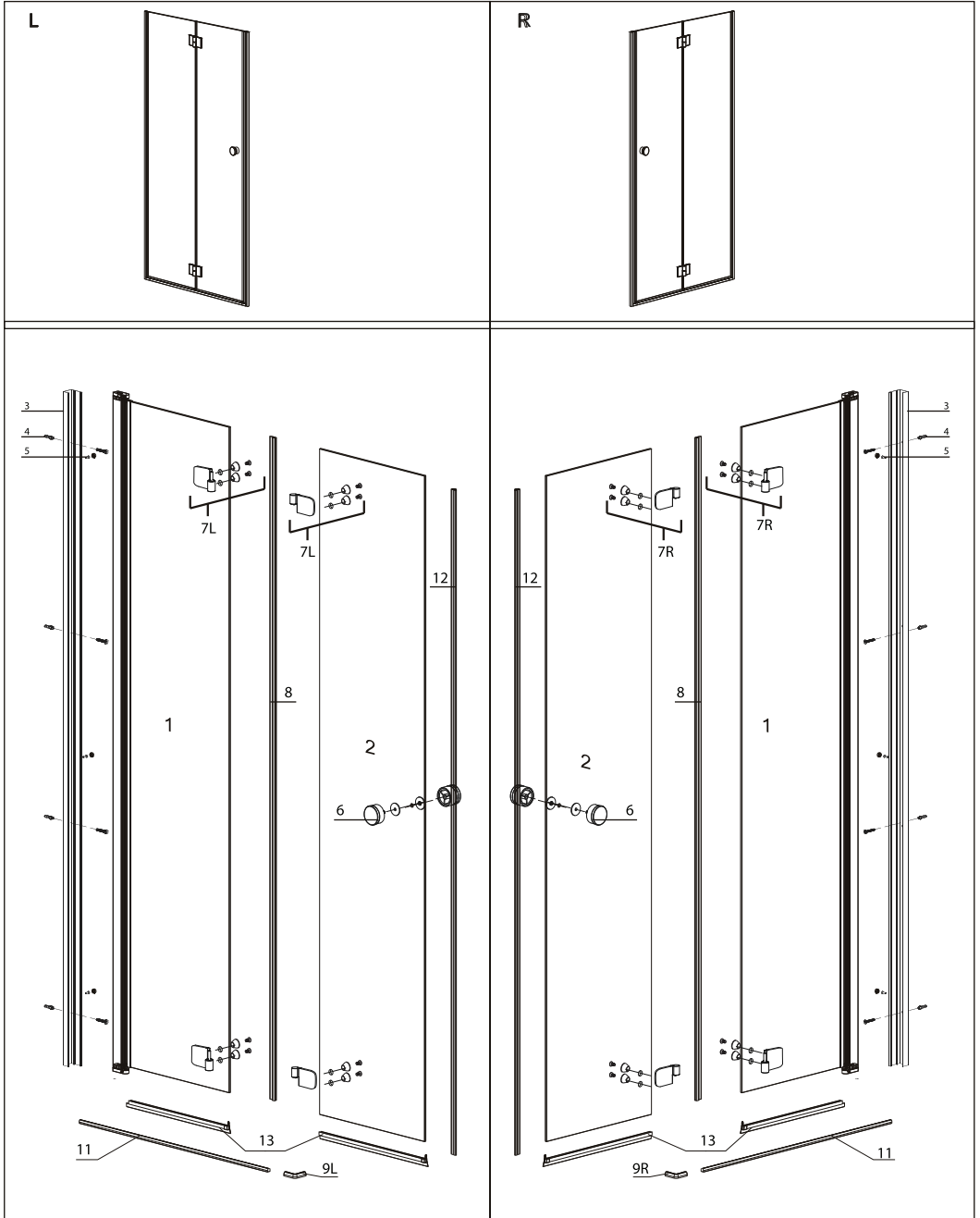



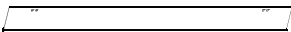

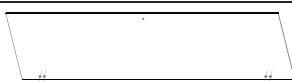

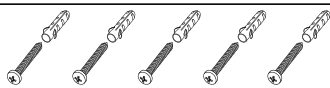



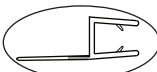

# SANOTECHNIK®

INTERNATIONAL

◆ Assembly Drawing

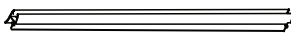

# ◆ Box Contents

1				X1					
2				X1					
3	NE1704B			X1					
4	DE-0138			X5					
5	DE0137B			X3					
6	NE0901B			X1					
7L*	HY1B-L			X2					
7R**	HY1B-R			X2					
8	DE-0156			X1					
9L*			+		9R*		+		X1
10	NE2201B			X1					
11	NE1719B			X1					
12	NE2304B			X1					
13	NE-2409			X1					

\*only for left enclosures  
\*\*only for right enclosures

# ◆ Installation Steps

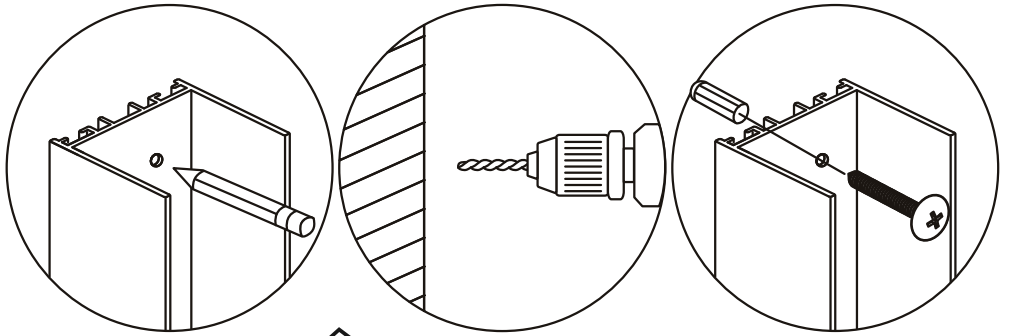

**1**

**2**

K/L	800/800	900/900	1000/1000
X	73-75	83-85	93-95
Y	73-75	83-85	93-95

