

- D Montageanleitung
 E Mounting Instruction
 HR Uputi za upotrebu
 SLO Navodilo za monta o kadi
 HU Útmutató a zuhanykabin beszereléséhez
 RO Instrucțiuni de montaj
 CZ Návod k montá I vany
 SK Návod na montáž
 TR Montaj Klavuzu
 BG Инструкции за монтаж

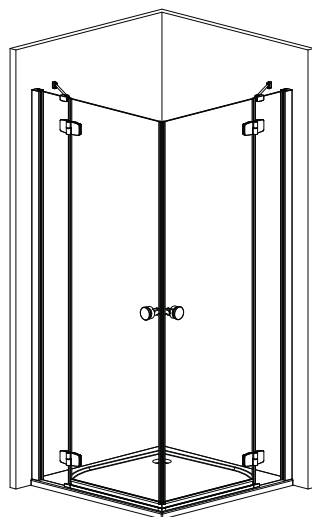

NOVA

CHROME

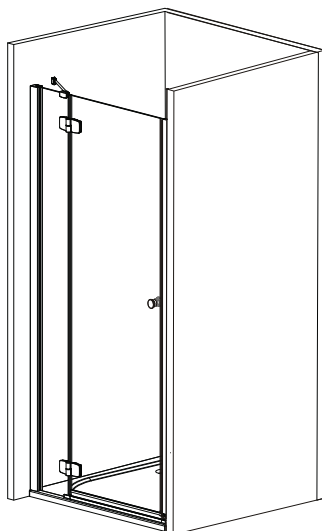

Symbol foto
202208

SANOTECHNIK
 Handelsgesellschaft m.b.H.
 Industriestraße 5
 A-2752 Wöllersdorf
 Tel.: +43 2622 / 421 93 0
 Fax: +43 2622 / 421 93 6
 office@sanotechnik.at
 www.sanotechnik.com

SANOTECHNIK Hungária Kft.
MAGYARORSZÁG
 Nagytétényi út 112
 H-1222 BUDAPEST
 Tel.: (+36 1) 424 06 70
 Fax: (+36 1) 424 06 79
 info@sanotechnik.hu
 www.sanotechnik.com

SC Sanotechnik COM Rumänien S.R.L.
ROMANIA
 Tancabestli, DN 1, KM 26,5
 Com. Snagov, jud. Ilfov
 Tel.: +40 21 350 13 43
 Fax: +40 21 350 13 44
 office@sanotechnik.ro
 www.sanotechnik.com







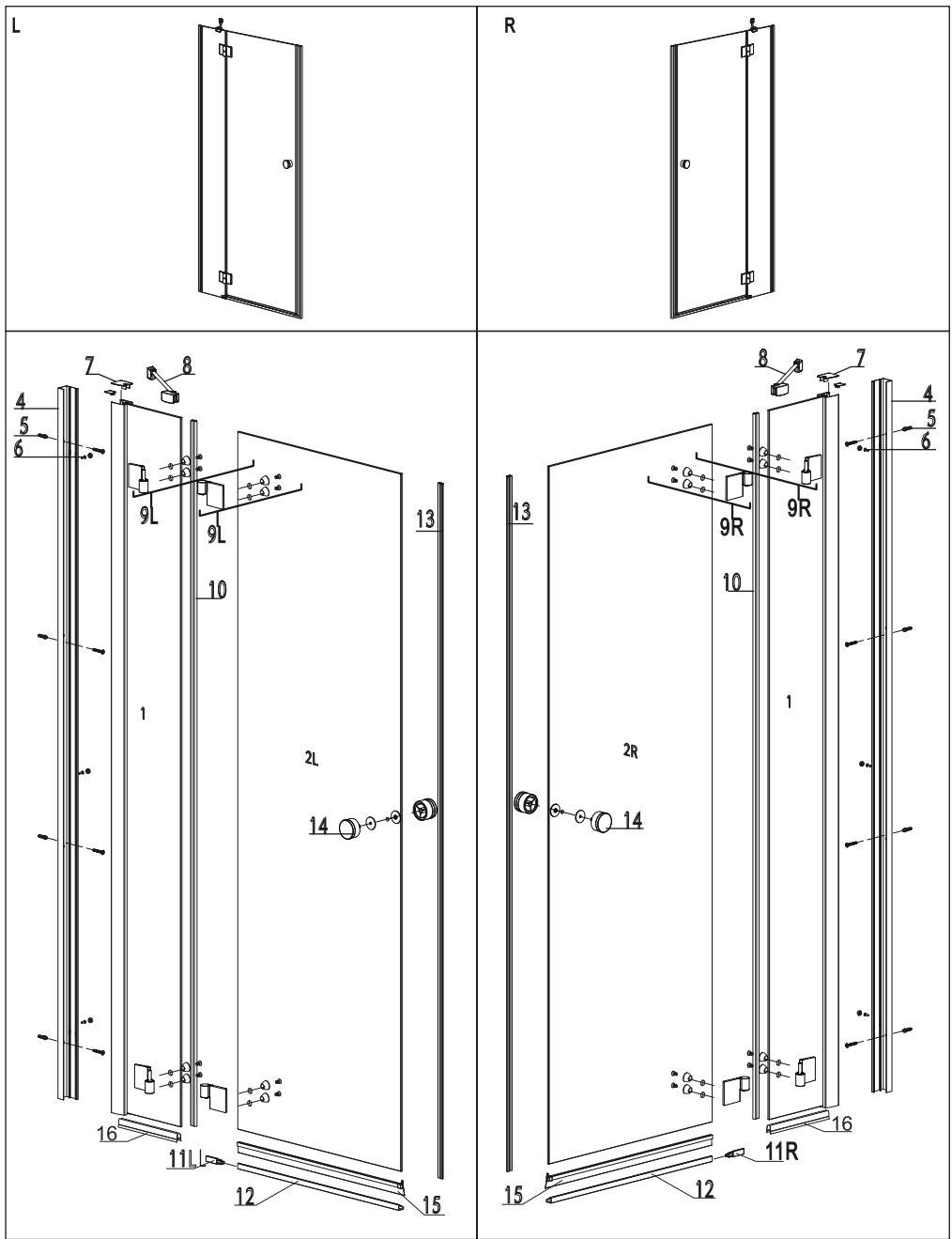



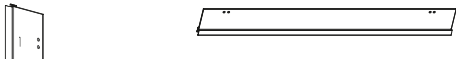

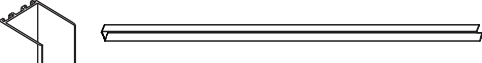

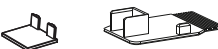
SANOTECHNIK d.o.o.
SLOVENIJA
 Stritarjeva ulica 24
 SI-2000 MARIBOR
 Tel. +3862/4213350
 Fax +3862/4213358
 info@sanotechnik.si
 www.sanotechnik.com

Sanotechnik Bulgaria Ltd.
BULGARIA
 3, Georgi Benev St.
 BG-4003 Plovdiv
 Tel: +359 32 961101
 Fax: +359 32 961102
 office@sanotechnik.bg
 www.sanotechnik.com

◆ Assembly Drawing

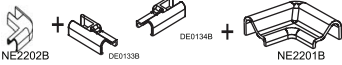
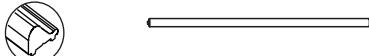

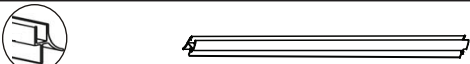
◆ Box Contents

1			X1
2L			X1
2R			X1
4	DE-0127		X1
5	DE-0138		X5
6	DE-0137		X3
7	NE-2204		X1
8	DE-0136		X1
9L *	HY1B-L		X2
9R **	HY1B-R		X2
10	DE-0156		X1
11R			X1
11L			X1
12	NE-1719		X1
13	NE-2304		X1
14	NE-0901		X1
15	NE-2409		X1
16	NE-2407		X1

*only for left enclosures
**only for right enclosures

◆ Installation Steps

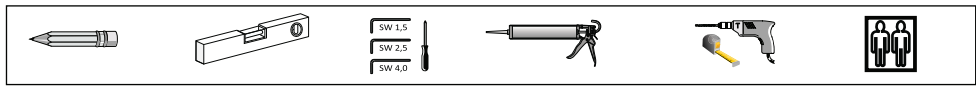

1 Place the shower tray in the corner and level it.

2 Measure the dimensions X and Y.

3 Mark the positions for the feet on the tray.

4 Drill holes for the feet.

5 Insert the feet into the tray.

6 Seal the tray to the wall and floor.

Dimensions:

- X: Tray width
- Y: Tray depth
- L: Foot width
- K: Foot height

K/L	800/800	900/900	1000/1000
X	73,8-75,8	83,8-85,8	93,8-95,8
Y	73,8-75,8	83,8-85,8	93,8-95,8

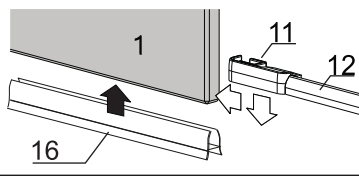
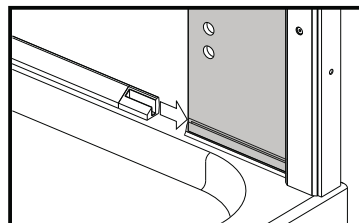
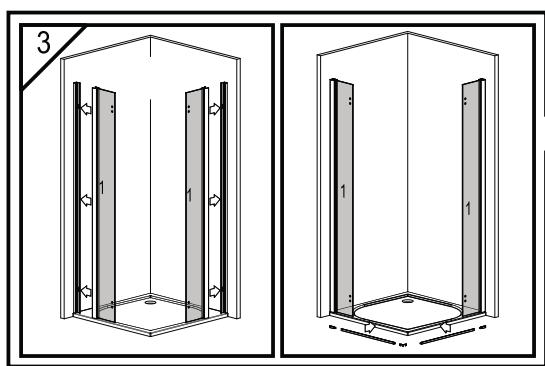
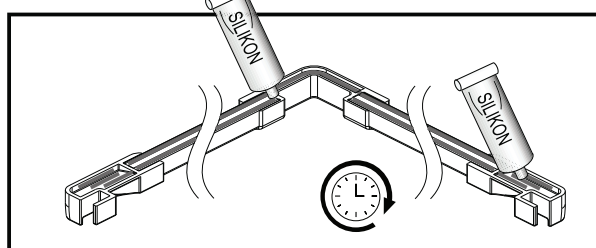
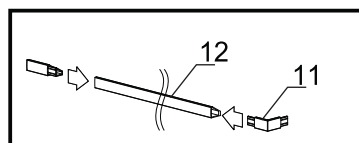
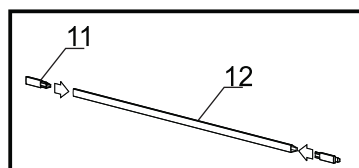
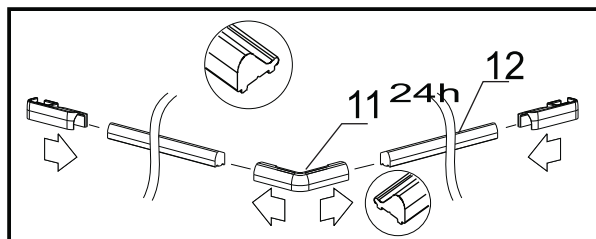
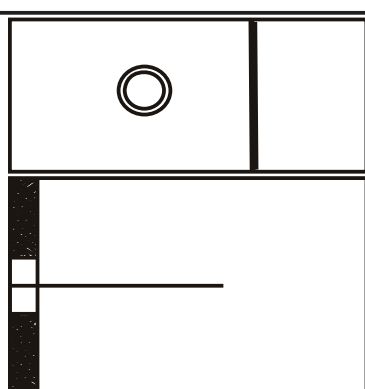
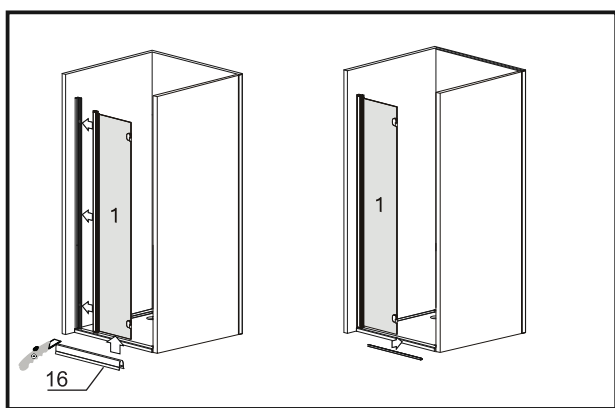

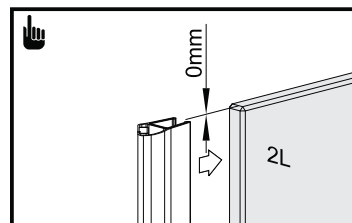
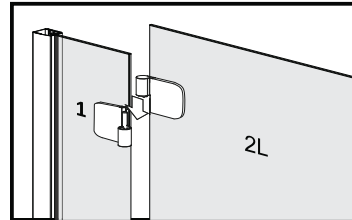
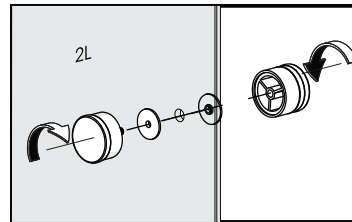
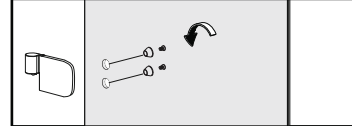
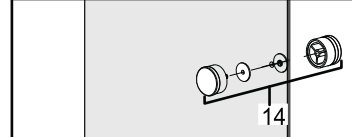
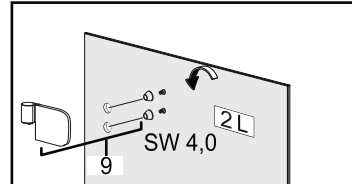
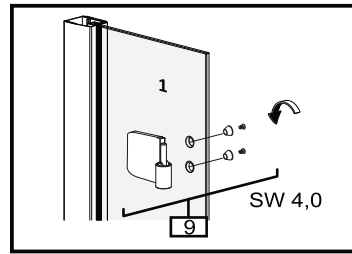
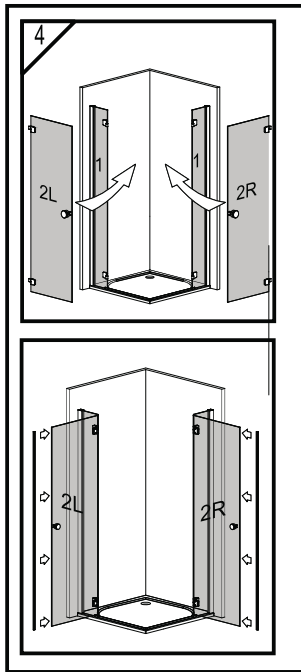

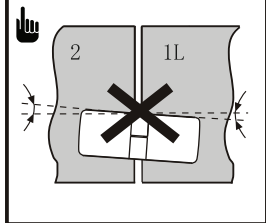
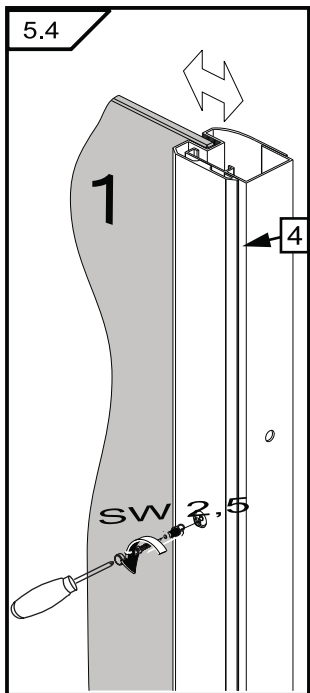
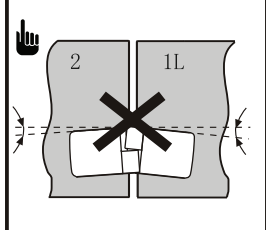
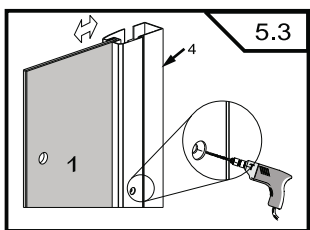
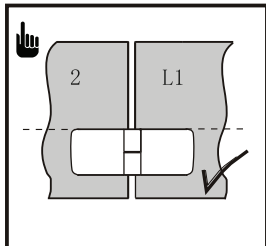
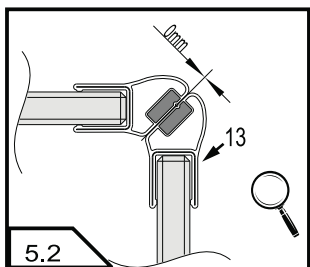
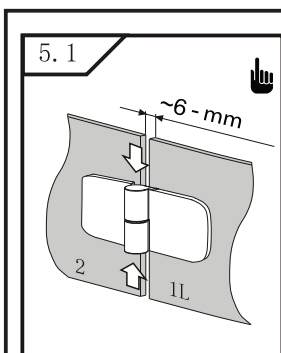
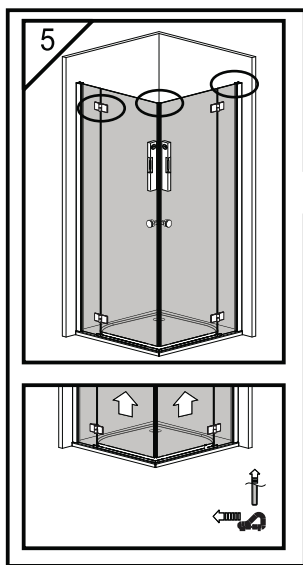

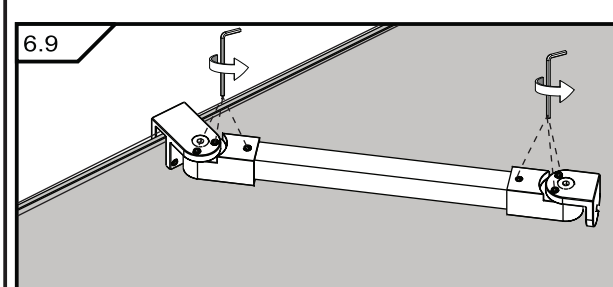
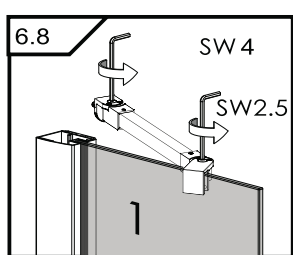
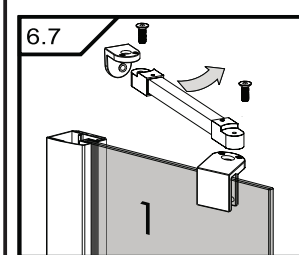
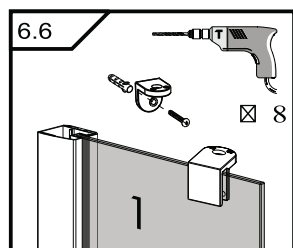
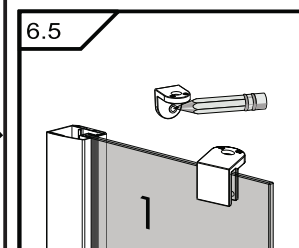
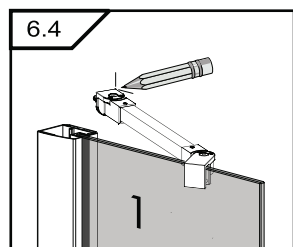
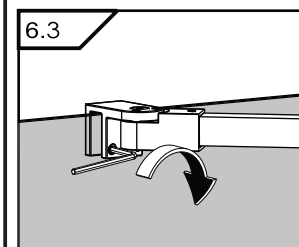
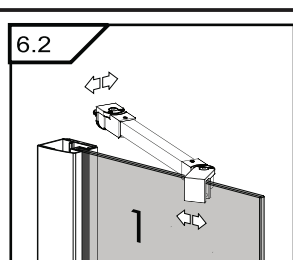
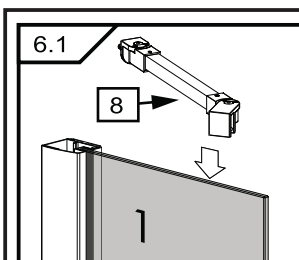
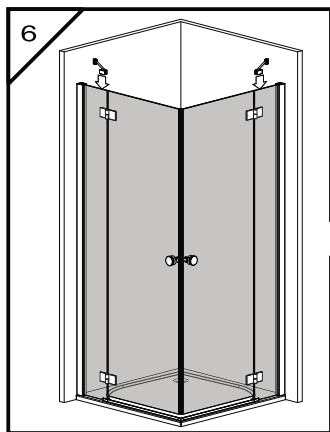

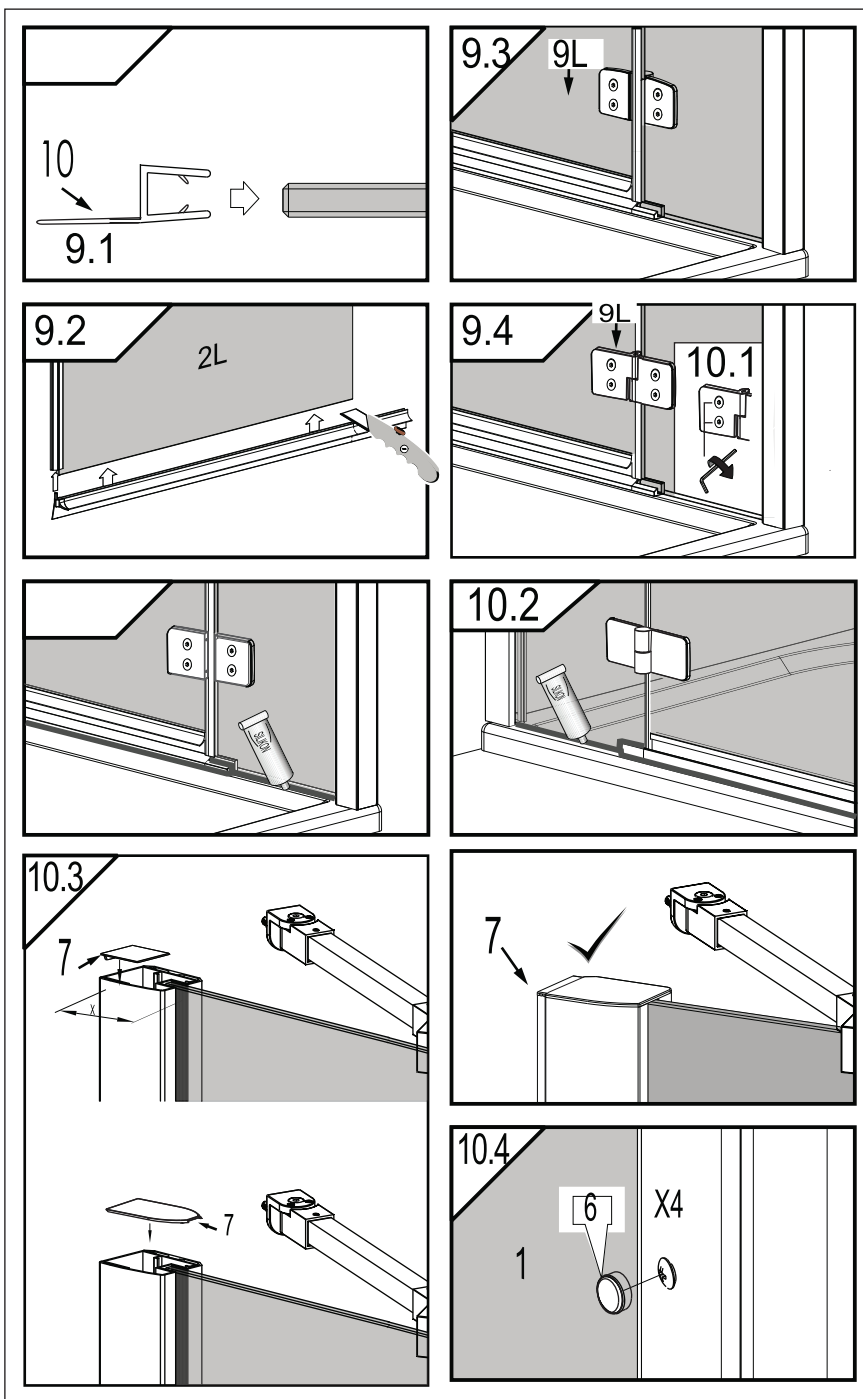

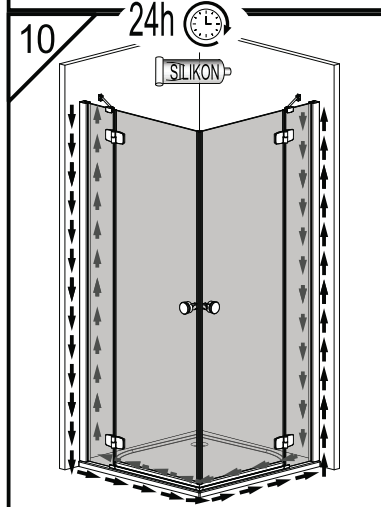
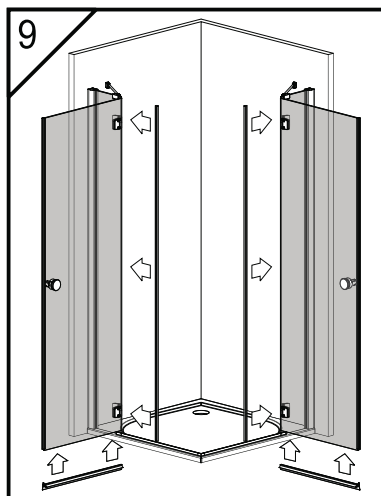

WE RECOMMEND THE REMOVAL
OF THE PERIMETER GLASS
PROTECTION AFTER THE
ASSEMBLY IS COMPLETE
OR SAFE TO HANDLE.



SANOTECHNIK
Handelsgesellschaft m.b.H.
Industriestraße 5
A-2752 Wöllersdorf
Tel.: +43 2622 / 421 93 0
Fax: +43 2622 / 421 93 6
office@sanotechnik.at
www.sanotechnik.com



SANOTECHNIK Hungária Kft.
MAGYARORSZÁG
Nagytétényi út 112
H-1222 BUDAPEST
Tel.: (+36 1) 424 06 70
Fax: (+36 1) 424 06 79
info@sanotechnik.hu
www.sanotechnik.com



SC Sanotechnik COM Rumänien S.R.L.
ROMANIA
Tancabesti, DN 1, KM 26,5
Com. Snagov, jud. Ilfov
Tel.: +40 21 350 13 43
Fax: +40 21 350 13 44
office@sanotechnik.ro
www.sanotechnik.com



SANOTECHNIK d.o.o.
SLOVENIJA
Stritarjeva ulica 24
SI-2000 MARIBOR
Tel. +3862/4213350
Fax +3862/4213358
info@sanotechnik.si
www.sanotechnik.com



Sanotechnik Bulgaria Ltd.
BULGARIA
3, Georgi Benev St.
BG-4003 Plovdiv
Tel: +359 32 961101
Fax: +359 32 961102
office@sanotechnik.bg
www.sanotechnik.com

SAN  **TECHNIK**®
INTERNATIONAL