

- D Montageanleitung
 E Mounting Instruction
 HR Uputi za upotrebu
 SLO Navodlilo za monta o kadi
 HU Útmutató a zuhanykabin beszereléséhez
 RO Instructiuni de montaj
 CZ Návod k montá I vany
 SK Návod na montáž
 TR Montaj Klavuzu
 BG Инструкции за монтаж

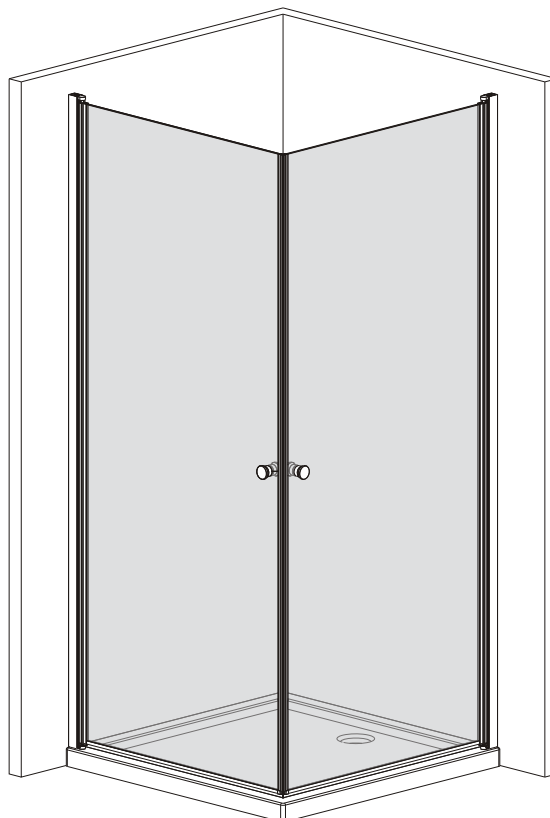

Symbol foto



SANOTECHNIK
 Handelsgesellschaft m.b.H.
 Industriestraße 5
 A-2752 Wöllersdorf
 Tel.: +43 2622 / 421 93 0
 Fax: +43 2622 / 421 93 6
 office@sanotechnik.at
 www.sanotechnik.com



SANOTECHNIK Hungária Kft.
MAGYARORSZÁG
 Nagytétényi út 112
 H-1222 BUDAPEST
 Tel.: (+36 1) 424 06 70
 Fax: (+36 1) 424 06 79
 info@sanotechnik.hu
 www.sanotechnik.com



SC Sanotechnik COM Rumänien S.R.L.
ROMANIA
 Tancabesti, DN 1, KM 26,5
 Com. Snagov, jud. Ilfov
 Tel.: +40 21 350 13 43
 Fax: +40 21 350 13 44
 office@sanotechnik.ro
 www.sanotechnik.com



SANOTECHNIK d.o.o.
SLOVENIJA
 Stritarjevca ulica 24
 SI-2000 MARIBOR
 Tel. +3862/4213350
 Fax +3862/4213358
 info@sanotechnik.si
 www.sanotechnik.com



SANOTECHNIK-MAUROD s.r.o.
SLOVAKIA& CZECHIA
 Sládkovičova 69
 SK-953 01 Zlaté Moravce
 Tel.: +421/376 426 245
 Fax : +421/376 426 246
 maurod@maurod.sk
 www.sanotechnik.com



Sanotechnik Bulgaria Ltd.
BULGARIA
 3, Georgi Benev St.
 BG-4003 Plovdiv
 Tel: +359 32 961101
 Fax: +359 32 961102
 office@sanotechnik.bg
 www.sanotechnik.com



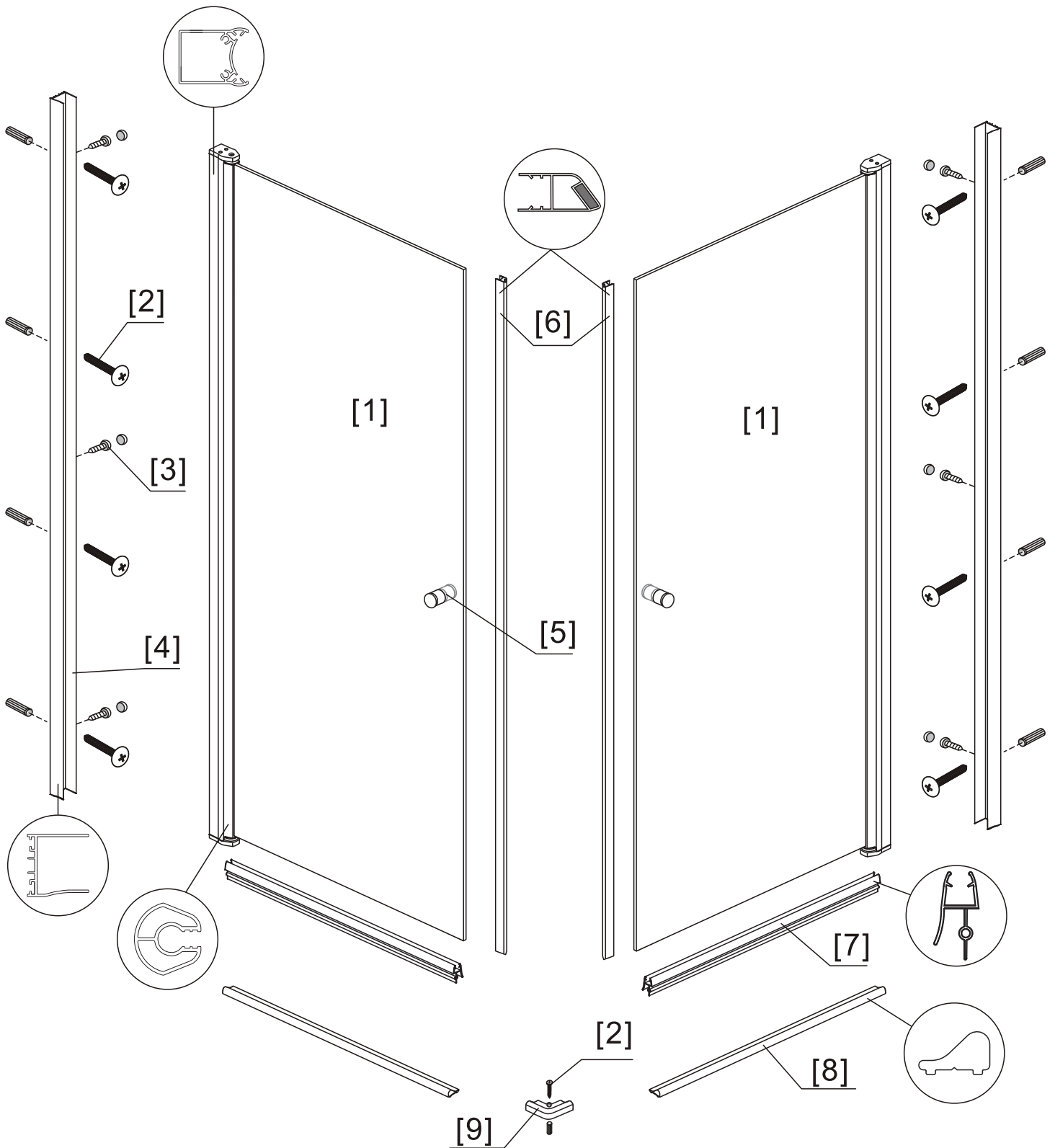

SANOTECHNIK®
 INTERNATIONAL

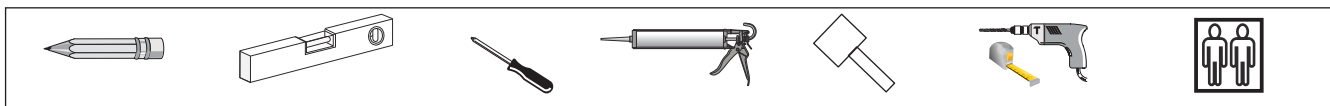
◆ Assembly Drawing



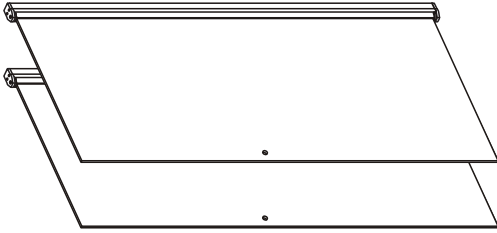
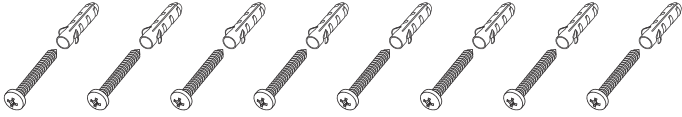

◆ Box Contents

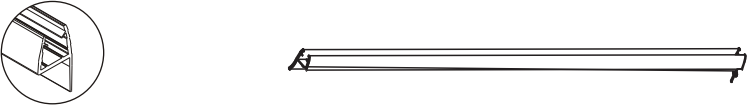
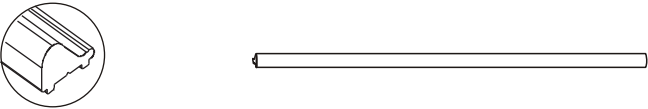
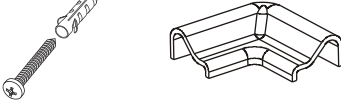
1		X2
2	 <p style="text-align: right;">ST 3.5X32</p>	X8
3	 <p style="text-align: right;">ST 3.5X13</p>	X6
4		X2
5		X2
6		X2
7		X2
8		X2
9	 <p style="text-align: right;">ST 3.5X32</p>	X1

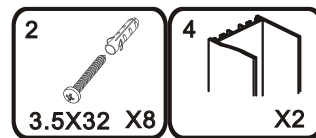
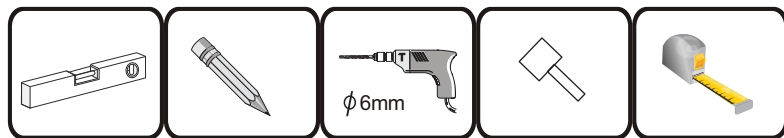

◆ Installation Steps

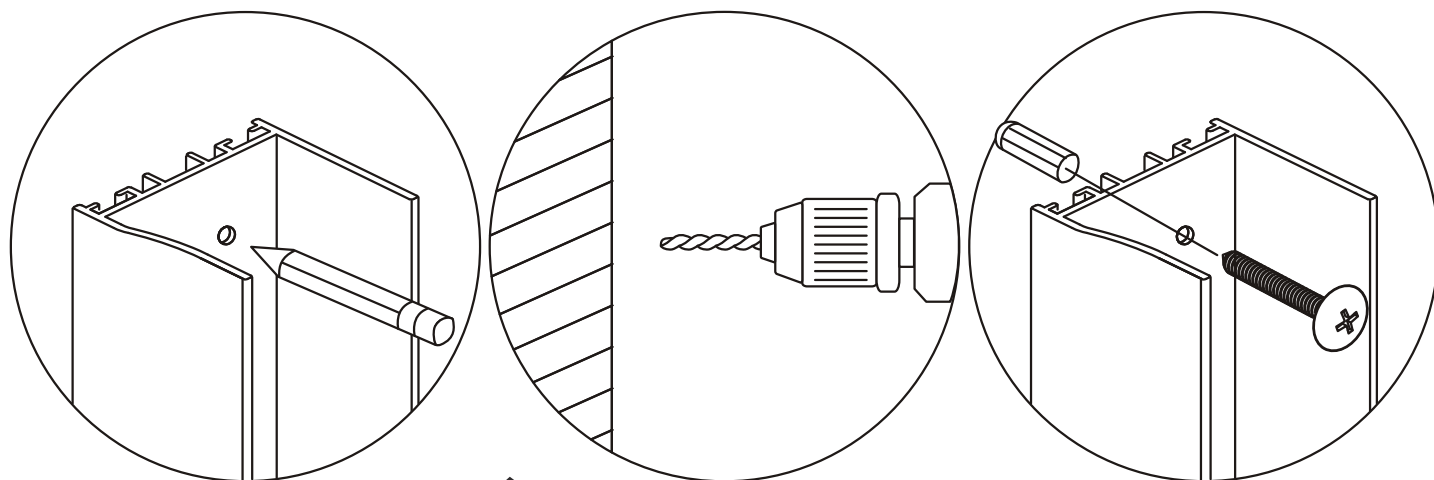

1

2

K/L	800/800	900/900	1000/1000
X	757*	857*	957*
Y	757*	857*	957*

