

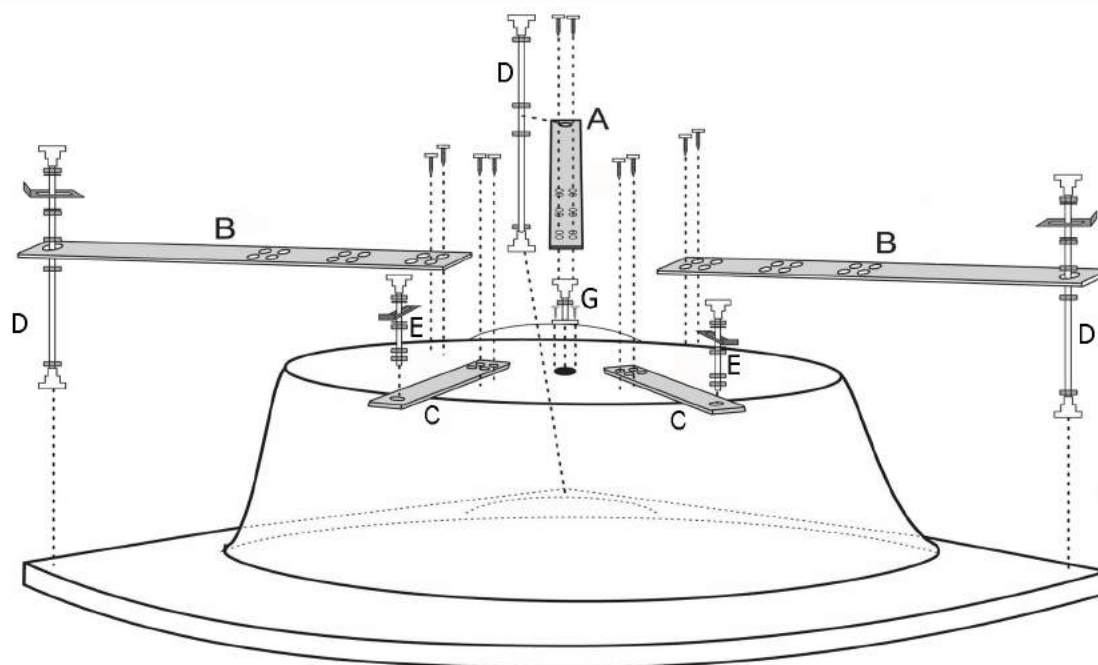

L 2200 Mounting Kit - Corner Bathtubs

Installation Instruction/ Montageanleitung/ Szerelési útmutató/
Navodila za montažo/ Instrucțiuni de instalare

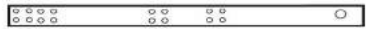



A  90 cm. x 1pcs.(U-profile - 5x2 cm.)

B  70 cm. x 2pcs.(U-profile - 5x2 cm.)

C  30 cm. x 2pcs.(U-profile - 5x2 cm.)

 x 26 pcs.(Screw 3.5x16)

 x 26pcs.

 x 8pcs.

 x 4pcs.(distant Spacer)

D  60 cm. x 3 (dowel)

E  21 cm. x 2(dowel)

F  x 8 (plastic foot)

G  x 1 = 14 cm.(stabilizing foot)

